

#### GENERAL DESCRIPTION:

---

Amphenol's line of D-Subminiature rack and panel connectors is part of an industry standard for applications requiring reliable, rugged, connectors. These connectors are designed to accommodate rack and panel, cable to panel and cable to cable applications. D-Subminiature connectors are pin and socket devices that employ contacts encased in a molded dielectric insert surrounded by a "D" shaped shell for polarization.

#### MARKETS:

---

Amphenol D-Subminiature connectors can be used in commercial, industrial or military markets. We offer a broad selection of dielectric materials and contact styles and configurations to meet all of your design requirements.

#### APPLICATIONS INCLUDE:

---

- Business equipment
- Electronic office systems
- Data communications
- Medical equipment
- Mobile communications
- Consumer electronics

#### AMPHENOL D-SUB FEATURES:

---

- Industry standard interfacing RS232 and RS449 mating configurations per EIA standards.
- UL Component Recognition File number E64911 (617, 841, 17, 17D, 17HD, ED, 17RR, 17SD, 117DF, 17BH, 17TW)
- Variations available:
  - Solder cup
  - Straight pc mount solder
  - Right angle pc mount solder
  - Solderless wire wrap
  - Crimp
  - High Density Right Angle
  - High Density Straight
  - Stacked Right Angle PC mount
  - Surface mount
- Five shell sizes offer widest choice of contact positions: 9, 15, 25, 37 and 50 in standard density and 15, 26, 44, 62 and 78 positions in high-density.
- Inserts are flame-retardant thermoplastic.
- Accessories for all applications are available including strain reliefs, cable clamps, shielded backshells, mating hardware and connector to pc board mounting hardware.
- Automatic and manual tooling is available for both crimp and IDC versions.
- Contact Amphenol for lease information.

**Fixed Machined Contact Connector**

- Standards: • UL File: E119881  
 • Connectors according to MIL C24308

**SPECIFICATIONS:**

**MATERIALS AND PLATINGS**

<b>Shells</b>	Steel yellow chromated over zinc or tinned steel with or without dimples on plug connector
<b>Insulator</b>	Glass-filled thermoplastic, UL 94V-0
<b>Rear Insert</b>	Brass, 118µ" up to 197µ" (3µm up to 5µm) tinned over nickel 78µ" up to 118µ" (2µm up to 3µm)
<b>Boardlock</b>	Tin-lead plating 157µ" up to 236µ" (4µm up to 6µm) over nickel 78µ" up to 118µ" (2µm up to 3µm)
<b>Screwlock</b>	Brass, 236µ" up to 394µ" (6µm up to 10µm) tinned over nickel 78µ" up to 118µ" (2µm up to 3µm)
<b>Contacts</b>	D: brass DF: pin = brass Socket = copper alloy
<b>Right Angle Version</b>	Selective gold in mating area over 78µ" up to 118µ" (2µm up to 3µm) nickel; 118µ" up to 197µ" (3µm up to 5µm) tin-lead on termination area over 78µ" up to 118µ" (2µm up to 3µm) nickel
<b>Straight Version</b>	Full gold plating over 78µ" up to 118µ" (2µm up to 3µm) nickel

**ELECTRICAL DATA**

<b>Current Rating</b>	7.5 A
<b>Voltage Rating</b>	300 V AC/rms 50Hz
<b>Withstanding Voltage</b>	1000V AC/rms 50Hz for one minute
<b>Insulation Resistance</b>	5000MΩ
<b>Contact Resistance</b>	D: 8.5mΩ max. DF: 5mΩ max.

**CLIMATIC DATA**

<b>Operating Temperature</b>	D: -67°F (-55°C) to +185°F (85°C), peak at 257°F (125°C) DF: -67°F (-55°C) to + 257°F (125°C)
------------------------------	--------------------------------------------------------------------------------------------------

**MECHANICAL DATA**

No. of Contacts	Mate (max.)	Unmate (min.)
9 (size E)	6.74 (3.05)	0.79 (0.36)
15 (size A)	11.24 (5.09)	1.01 (0.46)
25 (size B)	18.66 (8.44)	1.8 (0.81)
37 (size C)	27.65 (12.51)	2.47 (1.1)
50 (size D)	32.38 (14.65)	3.56 (1.6)

INCHES (MM)

**D-DF SERIES**

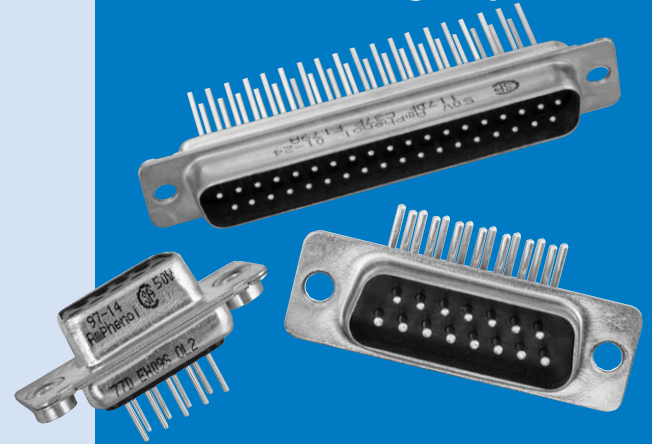

The Amphenol SD series features precision formed contacts, and 4 finger boardlocks.

This series gives you Amphenol's high standards of quality and reliability to meet all of your commercial requirements.

- Industrial
- Telecom
- Any industry standard I / O connections

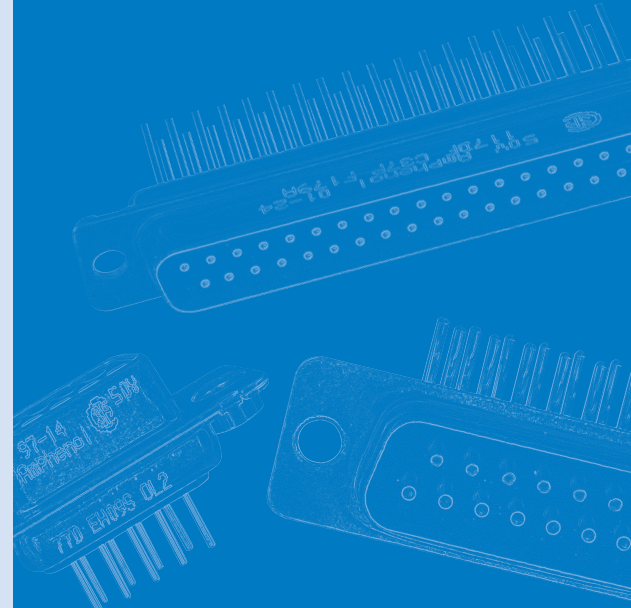

Solder cup

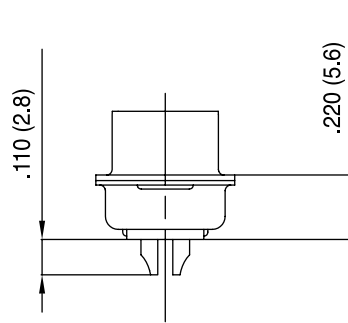

Wire Wrap

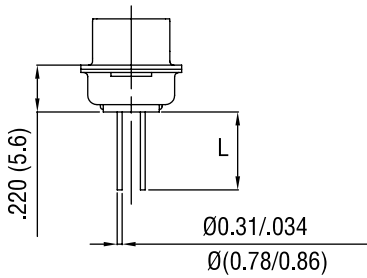

Termination	Nb of wraps	L
F179	2	.378 (9.6)
F179A	3	.512 (13)

Straight PCB

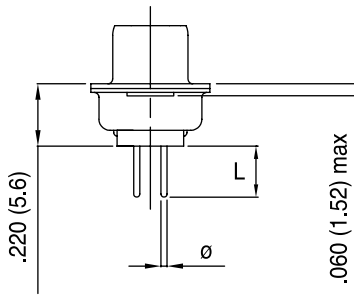

Termination	Ø	L
U	.024 (0.6)	.126 (3.2)
V	.040 (1.02)	.095 (2.4)
T	.024 (0.6)	.157 (4)
OL2	.02 (0.6)	.217 (5.5)

Grounding tabs

For straight termination

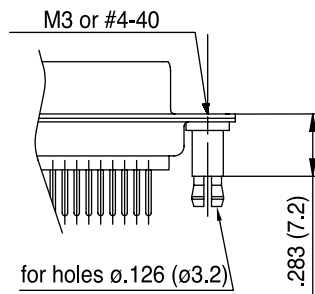

RM5

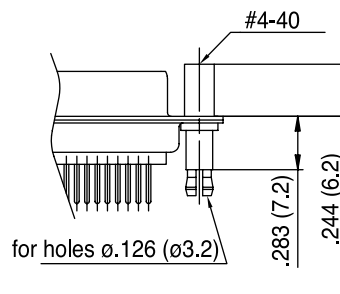

RM8

For R/A termination

FOR PCB .062 (1.6)

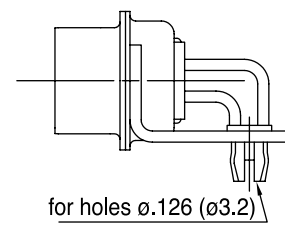

RM6

*For straight and R/A termination*

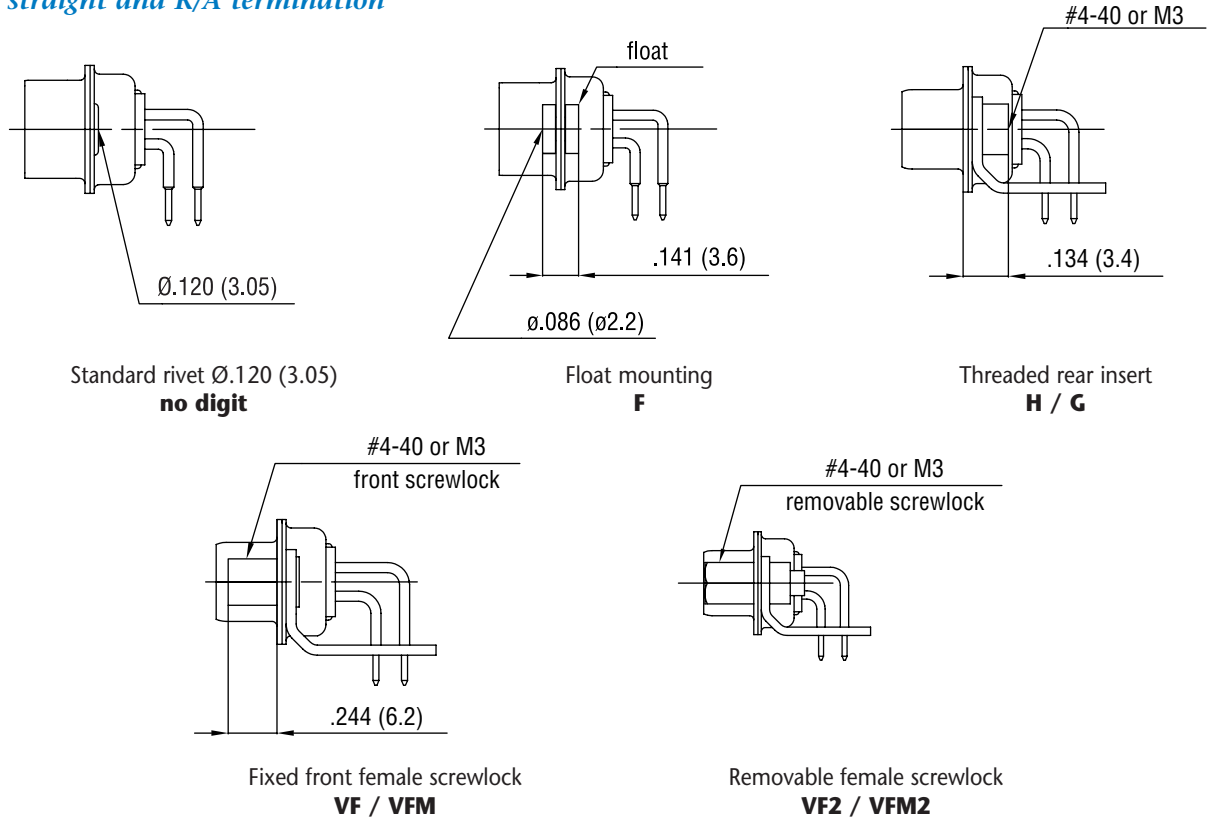

**RECOMMENDED PCB LAYOUT**

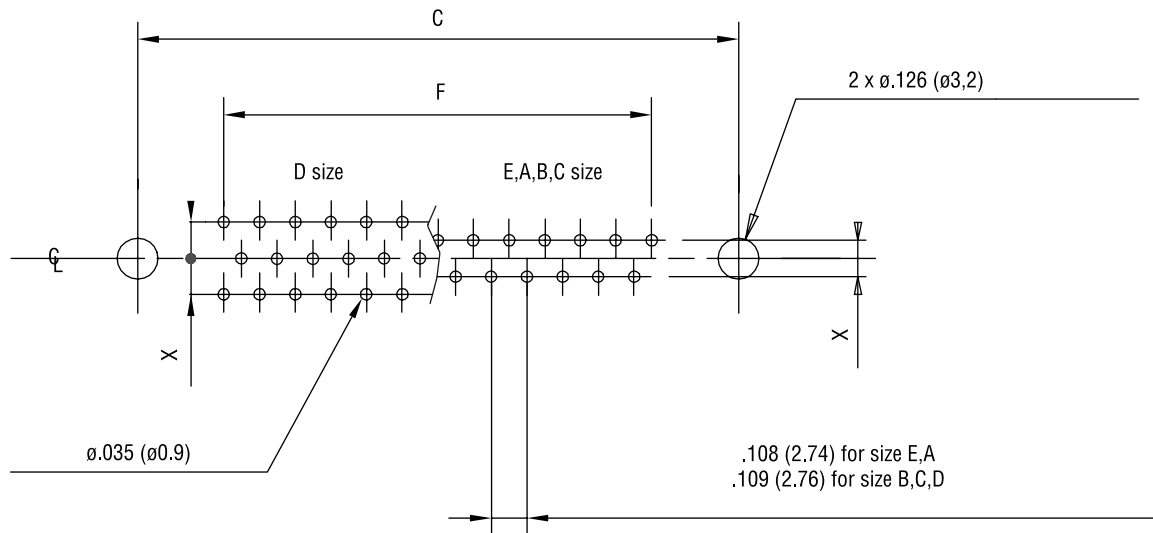

For straight PCB:  $X = .112$  (2.84)  
 For right angle PCB: MIL:  $X = .112$  (2.84)  
 European:  $X = .100$  (2.54),  $.112$  (2.84) in option

	size E	size A	size B	size C	size D
<b>C <math>\pm .004</math> (0.1)</b>	.984 (25)	1.311 (33.3)	1.85 (47)	2.5 (63.5)	2.406 (61.1)
<b>F <math>\pm .002</math> (0.05)</b>	.431 (10.96)	.755 (19.18)	1.304 (33.12)	1.956 (49.68)	1.74 (44.2)

INCHES (MM)

ORDERING INFORMATION

XXXXXX X X XX X XXXXX XXXX X

8µ" (0.2µm)	<b>17D:</b> yellow chromated shell <b>77D:</b> tinned shell for receptacle <b>717D:</b> tinned shell + dimples for plug
20µ" (0.5µm)	<b>17DF:</b> yellow chromated shell <b>77DF:</b> tinned shell for receptacle <b>717DF:</b> tinned shell + dimples for plug
30µ" (0.76µm)	<b>117DF:</b> yellow chromated shell <b>177DF:</b> tinned shell for receptacle <b>777DF:</b> tinned shell + dimples for plug

Shell size: E, A, B, C, D

Mounting Options:

- H rear insert 4-40
- G rear insert M3
- F float mounting
- no digit standard rivet .122 (ø 3.1)
- \*H, G must also be used to specify the threading of RM5 grounding tabs.

Configuration: 09, 15, 25, 37, 50

Contact type:

- P pin
- S socket

For specific product

Grounding tabs:

- RM5 for straight PCB mounting\*
- RM8 for straight PCB mounting + female lock
- RM6 for right angle PCB mounting
- VF front screwlock 4-40
- VFM front screwlock M3
- VF2 removable screwlock 4-40
- VF2M removable screwlock M3

Termination:

solder cup: no digit

Wire Wrap:

- F179 length .378 (9.6)
- F179A length .512 (13)

Straight PCB:

- U length .126 (3.2) tail ø.024 (ø0.6)
- V length .094 (2.4) tail ø.040 (ø1.02)
- T length .157 (4) tail ø.024 (ø0.6)
- OL2 length .216 (5.5) tail ø.024 (ø0.6)

Right Angle Connector:

MIL footprint

- without bracket: C tail ø.040 (ø1.02)
- A4 tail ø.024 (ø0.6)
- plastic bracket: AJ3 tail ø.040 (ø1.02)
- AJ4 tail ø.024 (ø0.6)
- metal bracket: A tail ø.040 (ø1.02)
- AM4 A ø.519 (13.2)
- AZ4 A ø.453 (11.5)
- AM4B footprint ø.590 (14.99)

European footprint

- without bracket: 1AON X .100 (2.54)
- 1BON X .112 (2.84)
- plastic bracket: 1APN X .100 (2.54)
- 1BPN X .112 (2.84)
- 1AUN X .100 (2.54)
- 1BUN X .112 (2.84)
- metal bracket: 1AMN X .100 (2.54)
- 1BMN X .112 (2.84)
- 1ATN X .100 (2.54)
- 1BTN X .112 (2.84)

■ : Standard options

For special request, please consult factory

For Filtered D-Sub, see page 56.

# TECHNICAL DATA

'' D '' SUBMINIATURE CONNECTORS

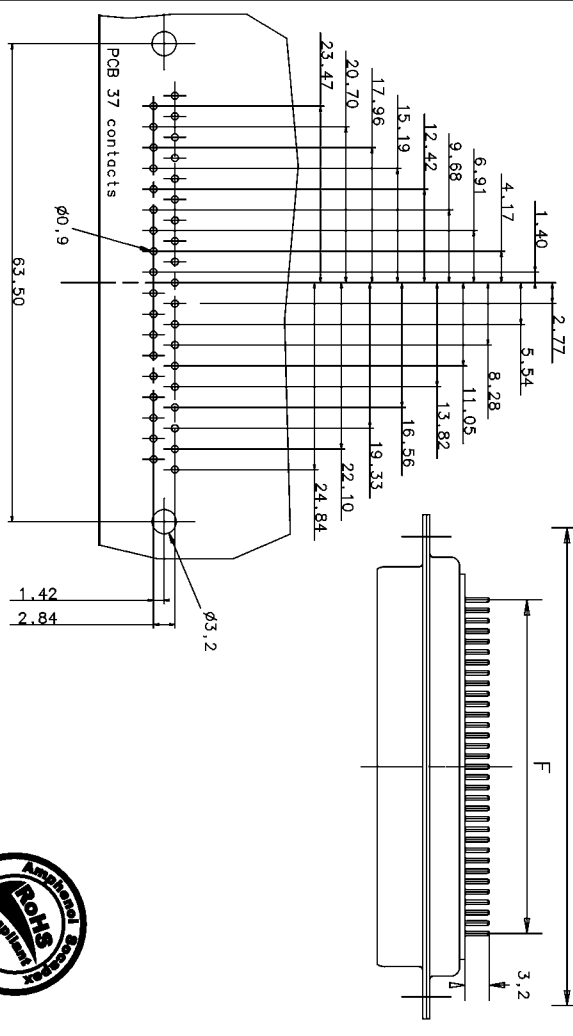
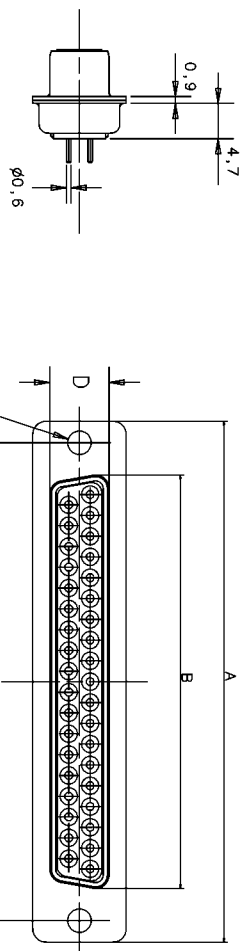
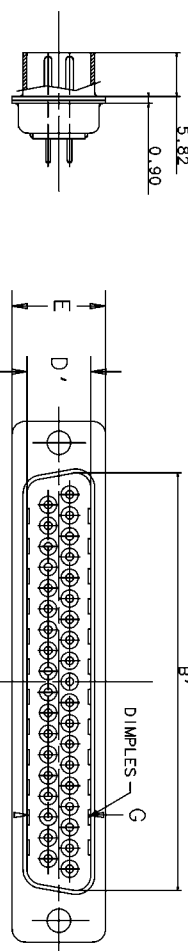

SHELL : Steel.

BODY : Glass filled thermoplastic.  
Flame retardant to UL 94 V-0.  
Colour : Black.

CONTACTS : Material for sockets : bronze.  
Material for pins : brass.  
Finish of contact mating area : Gold over Nickel.

ELECTRICAL : Voltage rating 300 V eff at 50Hz.  
Nominal current 7,5 A.  
Contact resistance <8.5m Ohms.  
Insulation resistance >5000 M Ohms.

CLIMATIC : Temperature range -55°C up to +85° C  
Damp heat 21 days (40° C - 95 % RH)  
Other climatic specifications in accordance with NF C 93-425

MECHANICAL : Mating and unmating force size

E	30 N max.	3,5 N mini.
A	50 N max.	4,4 N mini.
B	83 N max.	8,0 N mini.
C	123 N max.	11,0 N mini.
D	166 N max.	14,5 N mini.

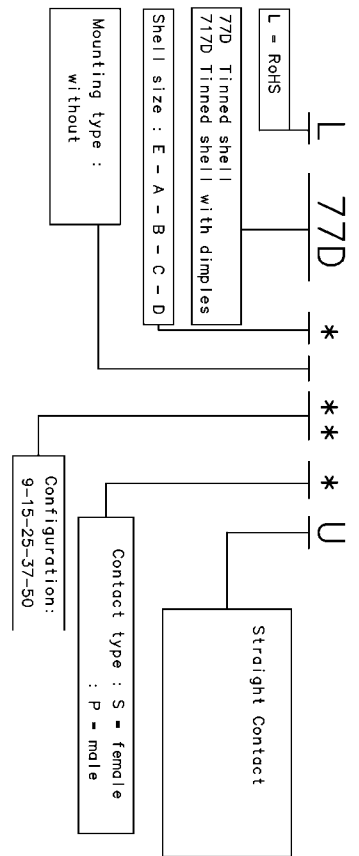

Foille feuille	A	B'	B	C	D'	D	E	F ±0,05	Pqs	G	*
E	30,43	16,21	17,94	25,12	8,93	8,48	12,93	10,98	2,74	7,62	2x3
A	38,76	24,79	25,32	33,20	9,93	8,48	12,93	19,20	2,74	7,62	2x5
B	53,45	38,25	38,84	46,91	9,93	8,48	12,93	33,12	2,76	7,62	2x8
C	68,94	54,97	55,50	63,57	9,93	8,48	12,93	49,68	2,76	7,62	2x12
D	87,35	82,50	82,88	80,29	10,82	10,33	14,55	44,20	2,76	10,5	2x12

Amphenol Socapex  
Usine de Dole

Creation plan 08/2016 Validé  
IND. MODIFICATION DATE Escalé/Approv

DESIGNATION L\*\*7D\*\*\*\*\*U

COMMUNICATION ET UTILISATION INTERDITES SAUF AUTORISATION